

Overview

HPE Apollo 2000 Gen10 Chassis

The HPE Apollo 2000 Gen10 System is a dense, multi-server platform that packs incredible performance and workload flexibility into a small datacenter space, while delivering the efficiencies of a shared infrastructure. It is designed to provide a bridge to scale-out architecture for traditional data centers, so enterprise and SME customers can achieve the space-saving value of density-optimized infrastructure in a cost-effective and non-disruptive manner.

The Apollo 2000 Gen10 System offers the configuration flexibility to support a variety of workloads, from remote site systems to large HPC clusters and everything in between. And it can be deployed cost-effectively starting with a single 2U, shared infrastructure chassis to meet the configuration needs of a wide variety of scale-out workloads.

The Apollo 2000 Gen10 System is a density-optimized, 2U shared infrastructure chassis for up to 4 ProLiant XL170r Gen10 and up to 2 ProLiant XL190r Gen10 independent, hot-plug servers with all the traditional data center attributes – standard racks and cabling and rear-aisle serviceability access. A 42U rack fits up to 20 Apollo r2000 series chassis accommodating up to 80 servers per rack.

With Apollo 2000 Gen10 System servers there is flexibility to tailor the system to the precise needs of each workload with compute and flexible I/O and storage options. Apollo 2000 System servers can be “mixed and matched” within a single chassis to support different applications and it can even be deployed with a single server, leaving room to scale as customer’s needs grow. One cannot use Gen9 servers in a Gen10 chassis or Gen10 servers in a Gen9 chassis.

The Apollo Gen10 2000 chassis comes with 4 new generation single rotor fans and an additional 4 fans can be added for redundancy. It supports up to 2 HPE Flexible Slot Power Supplies which provide up to 96% power efficiency with 80Plus Titanium-certified power supplies that lower server power requirements and reduce power waste in your data center. The chassis can also be managed by the HPE Advance Power Manager (HPE APM) an optional rack level manager.

What’s New

- New 2200W power supplies
-

Overview

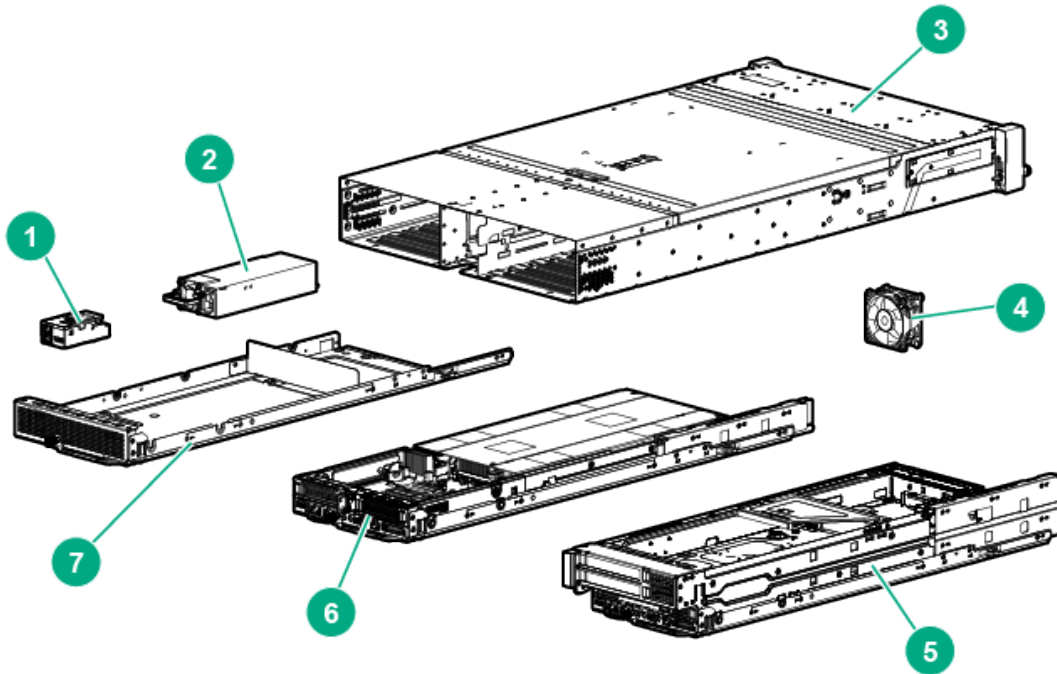

HPE Apollo r2200 12LFF Gen10 CTO Chassis – 12 LFF

Item	Description	Item	Description
1	RCM module (optional)	5	HPE ProLiant XL190r Gen10 Server
2	Power Supply	6	HPE ProLiant XL170r Gen10 Server
3	HPE Apollo 2000 Gen10 Chassis	7	Server tray blank
4	Chassis serial label pull tab		

Overview

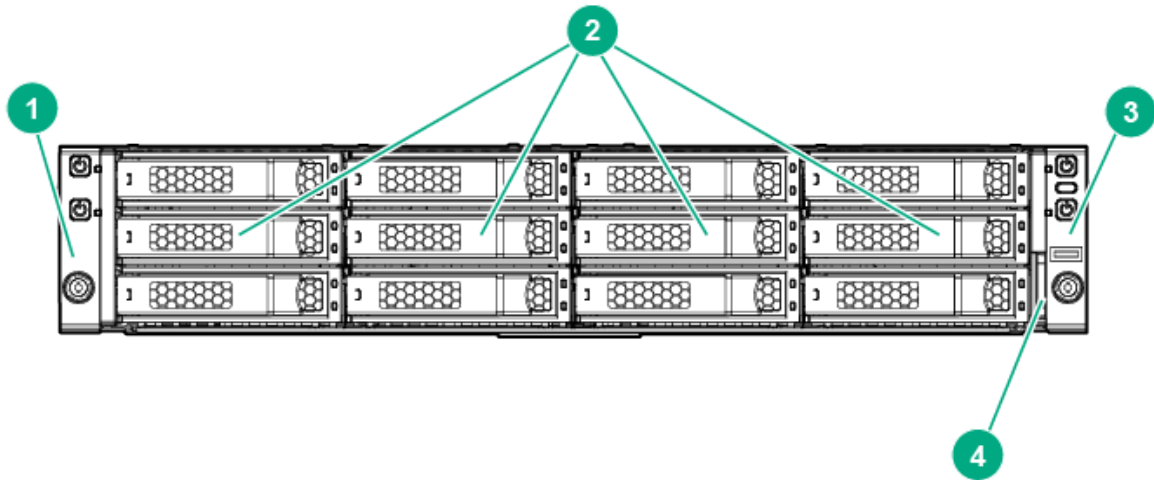

HPE Apollo r2200 12LFF Gen10 CTO Chassis – 12 LFF

Item	Description	Item	Description
1	Left bezel ear	3	Right bezel ear
2	Low-profile LFF hot-plug drives	4	Chassis serial label pull tab

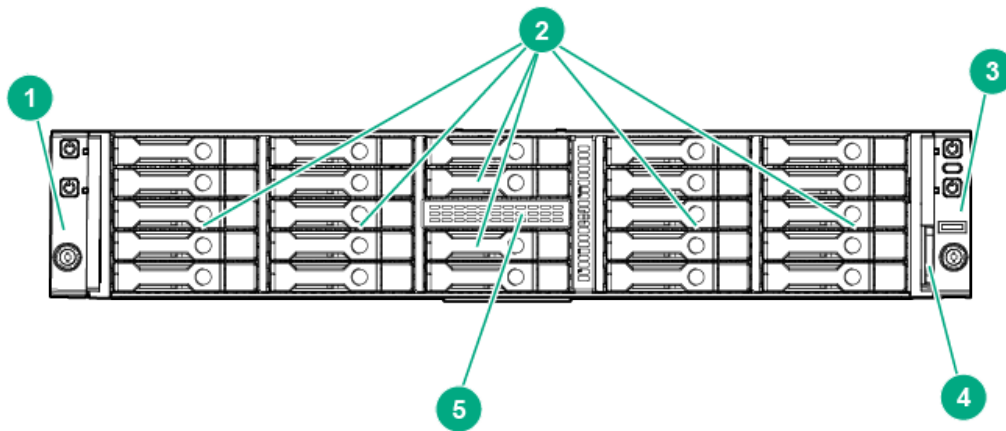

HPE Apollo r2600 24SFF-Prem Gen10 CTO Chassis – 24 SFF

Item	Description	Item	Description
1	Left bezel ear	4	Chassis serial label pull tab
2	SFF hot-plug drives	5	Non-removable bezel blank
3	Right bezel ear		

Overview

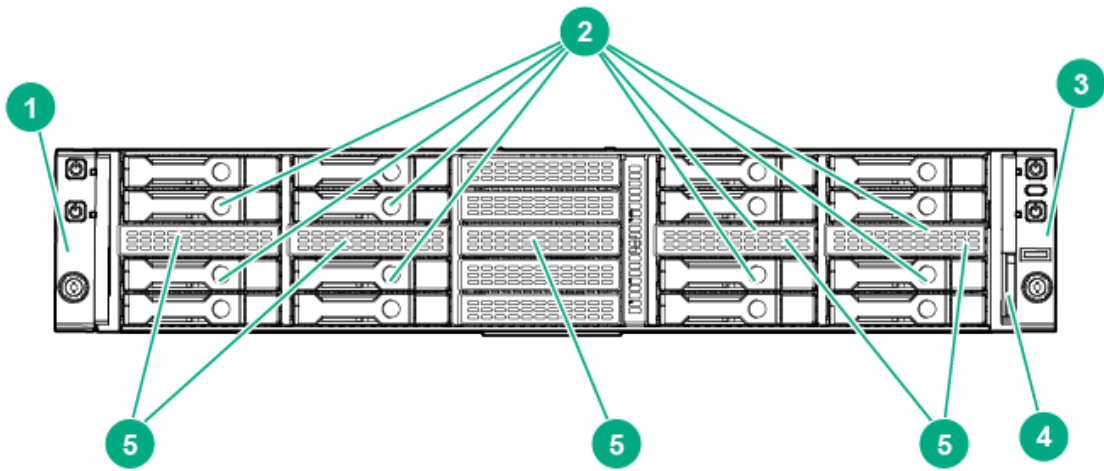

HPE Apollo r2800 24SFF-Flex Gen10 CTO Chassis- 16 NVMe

Item	Description	Item	Description
1	Left bezel ear	4	Chassis serial label pull tab
2	NVMe drives	5	Non-removable bezel blanks
3	Right bezel ear		

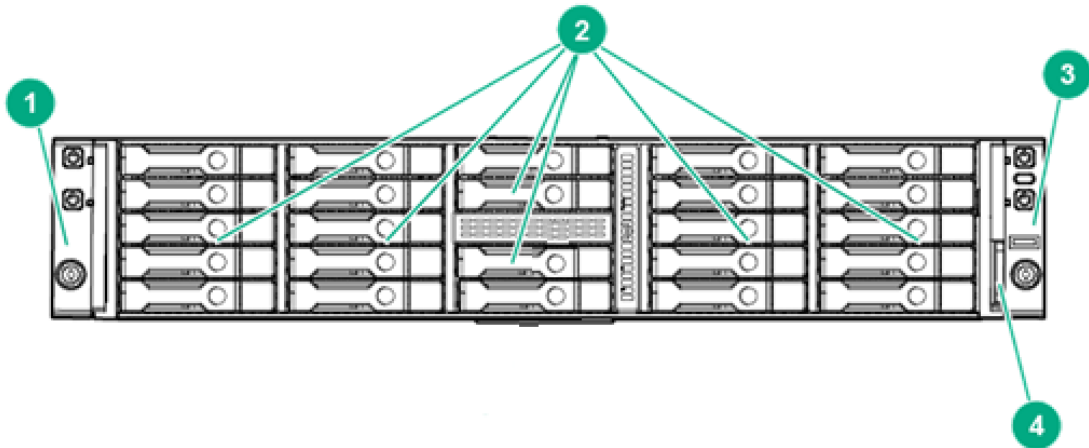

HPE Apollo r2800 24SFF-Flex Gen10 CTO Chassis- w/ SAS expander

Item	Description	Item	Description
1	Left bezel ear	3	Right bezel ear
2	SFF HP SmartDrives	4	Chassis serial label pull tab

Overview

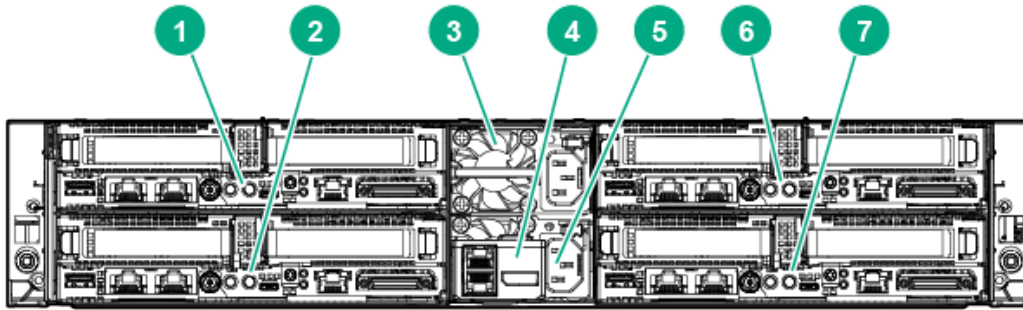

Item	Description
1	Server 4
2	Server 3
3	Power supply 2
4	RCM module (optional)

Item	Description
5	Power Supply 1
6	Server 2
7	Server 1

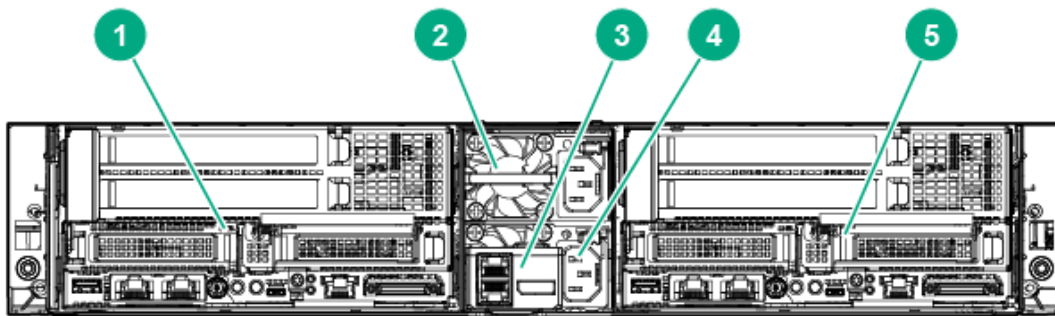

Chassis Rear panel Components / Two 2U Servers

Item	Description
1	Server 3
2	RCM module (optional)
3	Power Supply 2

Item	Description
4	Power Supply 1
5	Server 1

Core Features

Chassis

There are 4 chassis options with different storage configurations

- HPE Apollo r2200 12LFF Gen10 CTO Chassis – allocated equally across server nodes
 - 12 LFF hot-pluggable SAS/SATA HDD/SSD (Direct Attach)
- HPE Apollo r2600 24SFF-Prem Gen10 CTO Chassis – allocated equally across server nodes
 - 24 SFF hot-pluggable SAS/SATA HDD/SSD
 - 16 SFF SAS/SATA +8 NVMe HDD
- HPE Apollo r2800 24SFF-Flex Gen10 CTO Chassis
 - This chassis has 2 Backplane options
 - HPE r2800 Gen10 16SFF NVMe BP FIO Kit(16 SFF NVMe) : allocated equally across server nodes
 - HPE r2800 Gen10 24SFF BP w/EXP FIO Kit (SAS Expander) : allocated flexibly across server nodes

Each HPE Apollo 2000 Chassis is built with the following:

- Four server slots for a chassis
 - Up to two (2) 800W/1400W 277VAC/1600W power supply for the chassis HPE Thermal Logic technology for lower power consumption and airflow.
 - Four (4) single rotor fans standard and an additional 4 fans can be added for redundancy
-

System Fans

The Chassis ships standard with 4 single rotor fan modules.

Server Tray Blank Kit

A chassis requires that four (4) server tray slots be populated with either an HPE ProLiant XL170r Gen10, XL190r Gen10 server or an HPE Apollo 2000 Gen10 Server Node Blank Kit.

Rack Airflow Requirements

HPE Apollo 2000 Gen10 Chassis

The increasing power of new high-performance processor technology requires increased cooling efficiency for rack-mounted servers. For maximum cooling, HPE racks are recommended to allow these racks to be fully loaded with servers using the latest processors. For detail information please see Apollo 2000 System User Guide

CAUTION: If a third-party rack is used, observe the following additional requirements to ensure adequate airflow and to prevent damage to the equipment.

CAUTION: Always use blanking panels to fill all remaining empty front panel U-spaces in the rack. This arrangement ensures proper airflow. Using a rack without blanking panels will result in improper cooling that can lead to thermal damage.

Service & Support

Pointnext – Service and Support

It is recommended to have the same attached support level for all products included in the HPE Apollo 2000 chassis. The support of HPE Apollo 2000 the chassis covers the chassis, the included options, and APM. Support for the xl170r and xl190r are sold separately.

HPE Pointnext for Industry Standard Servers

HPE Pointnext provides a comprehensive portfolio including Advisory and Transformational, Professional, and Operational Services to help accelerate your digital transformation. From the onset of your transformation journey, Advisory and Transformational Services focus on designing the transformation and creating a solution roadmap. Professional Services specializes in creative configurations with flawless and on-time implementation, and on-budget execution. Finally, operational services provides innovative new approaches like Flexible Capacity and Datacenter Care, to keep your business at peak performance. HPE is ready to bring together all the pieces of the puzzle for you, with an eye on the future, and make the complex simple.

Recommended HPE Pointnext Services for your HPE Apollo 2000

Optimized Recommendation

Proactive Care, 24x7, three-year Support Service

HPE Proactive Care gives customers an enhanced call experience. When your products are connected to HPE, Proactive Care helps prevent problems and maintains IT stability by utilizing personalized proactive reports with recommendations and advice.

This Service combines three years proactive reporting and advice with our 24x7 coverage, four hour hardware response time when there is a problem. This service also includes collaborative software support for Independent Software Vendors (ISVs), (Red Hat, VMWare, Microsoft, etc.) running on your HPE servers.

<https://www.hpe.com/h20195/v2/getdocument.aspx?docname=4AA5-3259ENW>

NOTE: *HPE Proactive Care and HPE Proactive Care Advanced require that the customer connect their devices to make the most of these services and receive all the deliverables.

Standard Recommendation

Foundation Care 24x7, three-year Support Service

HPE Foundation Care 24x7 gives you access to HPE 24 hours a day, seven days a week for assistance on resolving issues. This service includes need based Hardware onsite response within four hours. In addition, collaborative software support is included in this service that provides troubleshooting assistance on industry leading software running on your HPE server. Simplify your support experience and make HPE your first call to help resolve hardware or software problems.

<https://www.hpe.com/h20195/V2/GetDocument.aspx?docname=4AA4-8876ENW&cc=us&lc=en>

Basic Recommendation

HPE Foundation Care NBD, three-year Support Service

HPE Foundation Care Next Business Day connects you to HPE during business hours for assistance on resolving issues. This service features need based next business day hardware onsite response and software call back within two hours. In addition, Collaborative software support and provides troubleshooting assistance on industry leading software running on your HPE server. Simplify your support experience and make HPE your first call to help resolve hardware or software problems.

<https://www.hpe.com/h20195/V2/GetDocument.aspx?docname=4AA4-8876ENW&cc=us&lc=en>

Related Services

HPE Datacenter Care service

HPE Datacenter Care helps you improve IT stability and security, increase the value of IT, and enable agility and innovation. It is a structured framework of repeatable, tested, and globally available services “building blocks.” You can deploy, operate, and evolve your datacenter wherever you are on your IT journey. With HPE Datacenter Care, you benefit from a personalized relationship with Hewlett Packard Enterprise via a single point of accountability for Hewlett Packard Enterprise and others’ products. For more information, visit <http://www.hpe.com/services/datacentercare>

Service & Support

HPE Flexible Capacity

With Flexible Capacity, you get the speed, scalability, and economics of the public cloud in the privacy of your data center. Gain the advantages of the public cloud—consumption-based payment, rapid scalability without worrying about capacity constraints. Reduce the “heavy lifting” needed to operate a data center. And retain the advantages that IT provides the business (i.e., control, security). Deliver the right user experience, choose the right technology for the business, manage privacy and compliance, and manage the cost of IT. And, you have the option to use the public cloud when needed

Datacenter Care for Hyperscale

Datacenter Care for Hyperscale is available for Service Providers and HPC customers who use a scale out approach to computing with a high volume homogenous infrastructure and resilient architecture can take advantage of this environment support tailored to their operating model.

HPE Installation and Startup Service

Provides for the installation of your HPE hardware according to product specifications including options. The HPE service delivery technician will connect the product to a LAN as appropriate and enable remote support to allow for automatic case creation for hardware failures. Installation and start up services also includes the installation of one supported operating system type (Windows® or Linux)

Factory Express for servers and storage

HPE Factory Express offers configuration, customization, integration and deployment services for Hewlett Packard Enterprise servers and storage products. Customers can choose how their factory solutions are built, tested, integrated, shipped and deployed.

Factory Express offers service packages for simple configuration, racking, installation, complex configuration and design services as well as individual factory services, such as image loading, asset tagging, and custom packaging. HPE products supported through Factory Express include a wide array of servers and storage: HPE Integrity, HPE ProLiant, HPE Apollo, HPE ProLiant Server Blades, HPE BladeSystem, HPE 9000 servers as well as the MSAXxxx3PAR suite, XP, rackable tape libraries and configurable network switches.

For more information on Factory Express services for your specific server model please contact your sales representative.

Data Privacy Services

Protect your data through better media management. HPE Data privacy services help manage and protect sensitive data to reduce the risk of unauthorized access to private information and help meet compliance requirements. Our retention services allow you to keep drives and other devices upon failure, our removal services provide convenient data sanitization and our recovery services allow you to safely retire IT assets and capture any remaining value from the hardware. [hpe.com/services/lifecycle](http://www.hpe.com/services/lifecycle) event

Additional can be found at: <http://www.hpe.com/services>

HPE Education Services

Keep your IT staff trained making sure they have the right skills to deliver on your business outcomes. Book on a class today and learn how to get the most from your technology investment. <http://www.hpe.com/ww/learn>

Connect your devices:

Unlock all of the benefits of your technology investment by connecting your products to Hewlett Packard Enterprise. Reduce down time and improve diagnostic accuracy with a single consolidated view of your environment. By connecting, you will receive 24x7 monitoring, pre-failure alerts, automatic call logging, and automatic parts dispatch. HPE Proactive Care Service and HPE Datacenter Care Service customers will also benefit from proactive activities to help prevent issues and increase optimization. All of these benefits are already available to you with your server storage and networking products, securely connected to HPE support. Learn more about getting connected at <http://www.hpe.com/services/getconnected>

Service & Support

Parts and Materials

Hewlett Packard Enterprise will provide HPE-supported replacement parts and materials necessary to maintain the covered hardware product in operating condition, including parts and materials for available and recommended engineering improvements. Parts and components that have reached their maximum supported lifetime and/or the maximum usage limitations as set forth in the manufacturer's operating manual, product quick-specs, or the technical product data sheet will not be provided, repaired, or replaced as part of these services.

The defective media retention service feature option applies only to Disk or eligible SSD/Flash Drives replaced by HPE due to malfunction.

NOTE: APM is covered under the HPE Service Contract applied to the HPE Apollo 2000 Chassis. No separate HPE support services need to be purchased

HPE Support Center

The HPE Support Center is a personalized online support portal with access to information, tools, and experts to support HPE business products. Submit support cases online, chat with Hewlett Packard Enterprise experts, access support resources or collaborate with peers. Learn more <http://www.hpe.com/support/hpesc>

The HPE Support Center Mobile App* allows you to resolve issues yourself or quickly connect to an agent for live support. Now, you can get access to personalize IT support anywhere, anytime.

HPE Insight Remote Support and HPE Support Center are available at no additional cost with a HPE warranty, HPE Support Service or HPE contractual support agreement.

*HPE Support Center Mobile App is subject to local availability

For More Information

To learn more on services for Hewlett Packard Enterprise Apollo please contact your Hewlett Packard Enterprise sales representative or Hewlett Packard Enterprise Authorized Channel Partner. Or visit: <http://www.hpe.com/services>

Warranty

This product is covered by a global limited warranty and supported by Hewlett Packard Enterprise Services and a worldwide network of Hewlett Packard Enterprise Authorized Channel Partners (may vary by region). Hardware diagnostic support and repair is available for three years from date of purchase. Support for software and initial setup is available for 90 days from date of purchase. Enhancements to warranty services are available through HPE Pointnext operational services or customized service agreements. Hard drives have either a one year or three year warranty.

NOTE: Server Warranty includes 3 year Parts, 3 year Labor, 3-year on-site support with next business day response. Warranty repairs may be accomplished through the use of Customer Self Repair (CSR) parts. These parts fall into two categories: 1) Mandatory CSR parts are designed for easy replacement. A travel and labor charge will result when customers decline to replace a Mandatory CSR part; 2) Optional CSR parts are also designed for easy replacement but may involve added complexity. Customers may choose to have Hewlett Packard Enterprise replace Optional CSR parts at no charge. Additional information regarding worldwide limited warranty and technical support is available at:

<http://www.hpe.com/support/ProLiantServers-warranties>

Step 1: Choose a Chassis

HPE Apollo r2200 Gen10 12 LFF Configure-to-order Chassis	867156-B21
HPE Apollo r2600 Gen10 24 SFF Premium Configure-to-order Chassis	867158-B21
HPE Apollo r2800 Gen10 24 SFF Flexible Configure-to-order Chassis	867159-B21

Choose a Backplane for r2800 chassis

HPE r2800 Gen10 16SFF NVMe Backplane FIO Kit	874800-B21
HPE r2800 Gen10 24SFF BP w/EXP FIO Kit	874797-B21

Configuration Information

Step 2: Choose cooling options

HPE Cooling Options

HPE Apollo 2000 Gen10 Server Node Blank Kit 874309-B21

NOTE: Required for any non-populated slots in the chassis to prevent thermal related issues

HPE r2x00 Gen10 Redundant Fan Module Kit 874308-B21

NOTE: Must select quantity for fan modules: 0 fan kit; 1 fan kit for Fan redundancy

Step 3: Choose the following rail kit and bracket per chassis

HPE Rail Kits

HPE 2U Gen9 Hardware Rail Kit 822731-B21

HPE Strap t2500 Shipping Bracket 740713-B21

NOTE: Hewlett Packard Enterprise recommends that a minimum of two people are required for all rack installations. Please refer to your installation instructions for proper tools and number of people to use for any installation.

Step 4: Choose Base configuration

Server Trays

HPE ProLiant XL170r Gen10 1U Node Configure-to-order Server 867055-B21

HPE ProLiant XL190r Gen10 2U Node Configure-to-order Server 867056-B21

NOTE: Up to 4 single half width server trays (XL170r Gen10) can be added to the HPE Apollo 2000 Chassis.

Up to 2 half width 2 U height server trays (XL190 Gen10) can be added to the HPE Apollo 2000 chassis

Core Options

RCM Module

HPE Apollo 2000 Rack Consolidation Module Kit 798211-B21

NOTE: This is an optional RCM (Rack Consolidation Management) module kit which allows iLO aggregation at the chassis level and also has the port for the HPE APM. The RCM Module consists of 2 iLO ports for redundancy. It can also be daisy chained to connect to a Top of the Rack (TOR) management switch.

NOTE: If using the RCM module iLO port connect to a network, the network must operate at a speed of 1Gb/s. On-board dedicated iLO management port could be ran at 10/100/1000 Gb network speed.

HPE Apollo 2000 Rack Consolidation Module 2.0-1.0 Adapter Kit 800063-B21

NOTE: Refer to HPE APM QuickSpecs for more details at:

<https://www.hpe.com/us/en/product-catalog/detail/pip.hpe-advanced-power-manager.5202410.html>

Power Supply

HPE 1600W Flex Slot Platinum Hot Plug Low Halogen Power Supply Kit 830272-B21

HPE 800W Flex Slot Platinum Hot Plug Low Halogen Power Supply Kit 865414-B21

HPE 800W Flex Slot -48VDC Hot Plug Low Halogen Power Supply Kit 865434-B21

HPE 1800W-2200W Flex Slot Platinum Hot Plug Power Supply Kit 876935-B21

HPE r2x00 Gen10 Power Supply Unit Enablement Kit 880186-B21

HPE r2x00 Gen10 1800-2200W Redundant Power Supply Enablement Kit 880189-B21

HPE 800W Flex Slot Universal Hot Plug Low Halogen Power Supply Kit 865428-B21

Security Hardware

HPE Gen10 2U Bezel Kit 867809-B21

HPE Bezel Lock Kit 875519-B21

HPE Advanced Power Manager

HPE Advanced Power Manager Kit 741192-B21

NOTE: Each HPE APM can connect up to 10 chassis via consolidated chassis management cable.

NOTE: Refer to HPE APM QuickSpecs for further details at

<https://www.hpe.com/us/en/product-catalog/detail/pip.hpe-advanced-power-manager.5202410.html>

Core Options

Power Cords

HPE SAFDGRID-SAFDGRID 277V 15Amp DC 0.76m Jumper Cord	J6W98A
HPE SAFDGRID-SAFDGRID 277V 15Amp DC 1.37m Jumper Cord	J6W99A
HPE SAFDGRID-SAFDGRID 277V 15Amp DC 2.0m Jumper Cord	J6X00A
HPE SAFDGRID-LS-25 277V 15Amp AC 0.76m Jumper Cord	J6X01A
HPE SAFDGRID-LS-25 277V 15Amp AC 1.37m Jumper Cord	J6X02A
HPE SAFDGRID-LS-25 277V 15Amp AC 2.0m Jumper Cord	J6X03A
HPE 48VDC 2.85m Power Cable	Q0H80A
HPE No Plug 12AWG 48V DC 3.0m Power Cord	J6X43A

NOTE: Below Power cords are compatible with 1800W-2200W Power Supply kit (876935-B21)

Power Cords – US

HPE C15 US 250V 15Amp 2.5m Black Power Cord	Q7F42A
HPE C15 US 250V 10Amp 2.5m Black Jumper Cord	Q7F57A
HPE C15 US 250V 10Amp 0.76m Black Jumper Cord	Q7F59A
HPE C15 US 250V 10Amp 1m Black Jumper Cord	Q7F61A

Power Cords – CN

HPE C15 CN 250V 10Amp 2.5m Black Power Cord	Q7F53A
---	--------

Power Cords – EU

HPE C15 EU 250V 10Amp 2.5m Black Power Cord	Q7F45A
HPE C15 EU 250V 10Amp 2.5m Black Jumper Cord	Q7F58A
HPE C15 EU 250V 10Amp 0.76m Black Jumper Cord	Q7F60A
HPE C15 EU 250V 10Amp 1m Black Jumper Cord	Q7F62A

Power Cords – UK

HPE C15 UK 250V 10Amp 2.5m Black Power Cord	Q7F46A
---	--------

Technical Specifications

HPE Apollo r2200 Gen10 Chassis – 12 LFF

Dimensions	Height	3.45 in (8.76 cm)
	Width	17.64 in (44.80 cm)
	Depth	34.62 in (87.93 cm)
Shipping Dimensions	Height	12.5 in (31.75 cm)
	Width	23.63 in (60.02 cm)
	Depth	39.38 in (100.01 cm)
Chassis Weight	Empty	28.88 lb (13.1 kg)
Max Enclosure Weight	Approximate	122.19 lb (46.70 kg)
Temperature Range	Operating	50° to 95° F (10° to 35° C)
	Non-Operating	-22° to 140° F (-30° to 60° C)
Relative Humidity	Operating	Minimum to be higher (more moisture) of -12°C (10.4°F) dew point or 8% relative humidity
	Non-Operating	5 to 95% relative humidity (Rh), 38.7°C (101.7°F) maximum wet bulb temperature, non-condensing.

NOTE: Operating temperature has an altitude derating of 1.8° F (1° C) per 1,000 ft (304.8 m). No direct sunlight. Upper operating limit is 10,000 ft (3,048 m) or 70Kpa/10.1 psia. Upper non-operating limit is 30,000 ft (9,144 m) or 30.3 KPa/4.4 psia. Storage maximum humidity of 95% is based on a maximum temperature of 113° F (45° C). Altitude maximum for storage is 70 KPa.

Acoustic Noise ***NOTE:** Please see QuickSpecs for Apollo 2000 Gen10 XL170r and XL190r servers

HPE Apollo r2600 Gen10 Chassis – 24 SFF

Dimensions	Height	3.45 in (8.76 cm)
	Width	17.64 in (44.80 cm)
	Depth	33.02 in (83.87 cm)
Shipping Dimensions	Height	12.5 in (31.75 cm)
	Width	23.63 in (60.02 cm)
	Depth	37.76 in (95.9 cm)
Chassis Weight	Empty	28.00 lb (12.7 kg)
Max Enclosure Weight	Approximate	103.27 lb (46.84 kg)
Temperature Range	Operating	50° to 95° F (10° to 35° C)
	Non-Operating	-22° to 140° F (-30° to 60° C)
Relative Humidity	Operating	Minimum to be higher (more moisture) of -12°C (10.4°F) dew point or 8% relative humidity
	Non-Operating	5 to 95% relative humidity (Rh), 38.7°C (101.7°F) maximum wet bulb temperature, non-condensing.

NOTE: Operating temperature has an altitude derating of 1.8° F (1° C) per 1,000 ft (304.8 m). No direct sunlight. Upper operating limit is 10,000 ft (3,048 m) or 70Kpa/10.1 psia. Upper non-operating limit is 30,000 ft (9,144 m) or 30.3 KPa/4.4 psia. Storage maximum humidity of 95% is based on a maximum temperature of 113° F (45° C). Altitude maximum for storage is 70 KPa.

Acoustic Noise ***NOTE:** Please see QuickSpecs for Apollo 2000 Gen10 XL170r and XL190r servers

Technical Specifications

HPE Apollo r2800 Gen10 Chassis 16 NVMe

Dimensions	Height	3.45 in (8.76 cm)
	Width	17.64 in (44.80 cm)
	Depth	33.02 in (83.87 cm)
Shipping Dimensions	Height	12.5 in (31.75 cm)
	Width	23.63 in (60.02 cm)
	Depth	37.76 in (95.9 cm)
Chassis Weight	Empty	28.00 lb (12.7 kg)
Max Enclosure Weight	Approximate	102.96 lb (46.70kg)
Temperature Range	Operating	50° to 95° F (10° to 35° C)
	Non-Operating	-22° to 140° F (-30° to 60° C)
Relative Humidity	Operating	Minimum to be higher (more moisture) of -12°C (10.4°F) dew point or 8% relative humidity
	Non-Operating	5 to 95% relative humidity (Rh), 38.7°C (101.7°F) maximum wet bulb temperature, non-condensing.

NOTE: Operating temperature has an altitude derating of 1.8° F (1° C) per 1,000 ft (304.8 m). No direct sunlight. Upper operating limit is 10,000 ft (3,048 m) or 70Kpa/10.1 psia. Upper non-operating limit is 30,000 ft (9,144 m) or 30.3 KPa/4.4 psia. Storage maximum humidity of 95% is based on a maximum temperature of 113° F (45° C). Altitude maximum for storage is 70 KPa.

Acoustic Noise

NOTE: Please see QuickSpecs for Apollo 2000 Gen10 XL170r and XL190r servers

Environmental-friendly Products and Approach – End-of-life Management and Recycling

Hewlett Packard Enterprise offers end-of-life **product return, trade-in, and recycling programs** in many geographic areas, for our products. Products returned to Hewlett Packard Enterprise will be recycled, recovered or disposed of in a responsible manner. The EU WEEE Directive (2012/19/EU) requires manufacturers to provide treatment information for each product type for use by treatment facilities. This information (product disassembly instructions) is posted on the **Hewlett Packard Enterprise web site:** These instructions may be used by recyclers and other WEEE treatment facilities as well as Hewlett Packard Enterprise OEM customers who integrate and re-sell Hewlett Packard Enterprise equipment.

Summary of Changes

Date	Version History	Action	Description of Change
01-Oct-2018	Version 6	Changed	SKUs descriptions in the Configuration Information and Core Options were updated
13-Aug-2018	Version 5	Changed	Overview and SKUs descriptions in the Configuration Information and Core Options were updated.
04-Jun-2018	Version 4	Changed	Update SKUs in the Core Options section
02-Apr-2018	Version 3	Updated	Update Overview, Configuration Information and Core Options sections
09-Oct-2017	Version 2	Updated	Update SKUs in the Configuration Information section
25-Sep-2017	Version 1	New	New QuickSpecs.



Sign up for updates



© Copyright 2018 Hewlett Packard Enterprise Development LP. The information contained herein is subject to change without notice. The only warranties for Hewlett Packard Enterprise products and services are set forth in the express warranty statements accompanying such products and services. Nothing herein should be construed as constituting an additional warranty. Hewlett Packard Enterprise shall not be liable for technical or editorial errors or omissions contained herein.

Microsoft and Windows NT are US registered trademarks of Microsoft Corporation.

Intel, the Intel logo, Xeon and Xeon Inside are trademarks of Intel Corporation in the U.S. and other countries.

AMD Opteron™ is a US registered trademark of AMD Corporation.

a00019876enw - 16063 - Worldwide - V6 - 01-October-2018